

ELECTRIC ACTUATORS for industrial valve automation



Multi-turn actuator: Gate



Linear actuator: globe valve



Part-turn actuator: Butterfly valve
Plug Valve, Ball valve



Part-turn actuators with base
and lever: Damper baffle



About GEKO

GEKO—The specialist for electric actuators

04

Basics

Applications

06

Outstanding advantages

08

Scope of application

10

Design structure

11

Service conditions

14

Communication

Communication - tailor-made interfaces

18

Communication - fieldbus

20

Communication - HART

24

SIMA - the fieldbus system solution

26

Alternative communication channels - Wireless and fibre optic cables

28

Design

GKSA...Series rotary electric actuators--product specification

30

GST.../GK...Series multi-turn reduction gear box

31

GKSA...Series linear electric actuators

32

LE...Series linear propulsion plant technical data

33

GKSA...Series direct-connected quarter-turn electric actuator

34

GS...Series accessories device

35

GKSA...Series foot-mounted quarter-turn electric actuators

36

GF...Series accessories device

37

Certifications

38



GEKO-THE SPECIALIST FOR ELECTRIC ACTUATORS

Germany GEKO Fluid Control GmbH is under the GEKO Union GmbH&Co.KG, was born in Germany, North Rhine-Westphalia Dusseldorf. In Europe it is a well-known pneumatic and electric control valve professional manufacturer, and in the implementation of the actuator, the control valve has been developed ten years, is one of the pioneers of global producers of flow control valve.

GEKO is committed to the development of new products and strict adherence to the quality control system, relying on advanced technology and reliable performance, are specialised in electric actuators for the energy, water, oil & gas, as well as industrial sectors.

Modular concept

GEKO are entirely devoted to pursue their modular product concept. A comprehensive range of sub-assemblies allows for configuration of customer-specific actuators accommodating the required application. The range of variants is only possible due to clear interfaces between components while placing the highest demands on product quality as well as easy and straightforward maintenance of GEKO actuators.

Innovation on a day-to-day-business

As specialist for electric actuators, GEKO set the market standard for innovation and sustainability. Within the framework of continual improvement, their own in-house vertical range of manufacture guarantee prompt implementation on both product or sub-assembly level. This applies to all areas relating to device function - mechanical, electrical, electronic, and software engineering.

Selecting GEKO:

- > provides valve automation in compliance with submitted specifications
- > assures safety for design and implementation for plant engineering on the basis of certified interfaces
- > guarantees the operator global on site service including commissioning, comprehensive support, and product training.



In 2005, the products of GEKO entered the Chinese market. The field of customers includes electricity, petrochemical, nuclear power, mine, steel mill, aerospace, municipal engineering and so on. It's used and well known by many Chinese customers. According to the needs of the Chinese market's development, Changzhou GEKO Automation Equipment Co., Ltd. which is China Office was formally established at the year of 2008. We have opened Office in Shenzhen, Chongqing, Dalian, after-sale service center, and logistics distribution center. It's convenient and high-efficiency that managing and serving the customer of the Asia-Pacific region and the China.

At present, Changzhou GEKO Automation Equipment Co., Ltd has offered the perfect solution and the services of technology for many project in China, which accumulate rich experience in project, help our customer to reduce resources, and improves system efficiency. After many years of experience in product application, our company has built an reputation in various industry, and become one of first preferred brands for the customer and equipment supplier.

Selecting GEKO:

- > High-quality Products come from every details of the motives, every product contain our enthusiasm and professionalism.
- > We devote our mind to weighing the technology of product details and the technology innovation, so that we can provide a complete solution of fluidic control for our customer.
- > Only pioneers can advance with the times! We set up our example in the field of industrial automation by the international standard and the personal all-round service. We will continuously devote our passion and excellent product to our world.



APPLICATIONS

WATER

- > Sewage treatment plants
- > Water treatment plants
- > Drinking water distribution
- > Sewage disposal
- > Seawater desalination
- > Steel constructions for water systems

Drinking water abstraction and distribution, as well as sewage disposal and purification are basic prerequisites for infrastructure development. Security of supply is crucial for modern water industry. Piping of different lengths and nominal diameters must be automated with a multitude of valve types. GEKO actuators are widely used in civil engineering constructions for water applications to operate weirs and sluice gates. GEKO are well implanted in the water industry due to their broad product portfolio including multi-turn, part-turn, and linear actuators. In combination with high corrosion protection, they guarantee a long service life, low in maintenance.

ENERGY

- > Fossil power plants (coal, gas, oil)
- > Nuclear power plants
- > Cogeneration power plants
- > District heating
- > Hydroelectric power plants
- > Geothermal power plants
- > Solar thermal power plants
- > Biogas power plants

Power plants consisting of systems such as water and steam circuits, flue gas purification, cooling tower, boiler systems, and turbines. The control system regulates the processes within these systems to be visualised within the control room. Electric actuators mounted to valves control water and steam flows within piping systems. GEKO actuators offer an interface for all automated valves adapted to the power plant control systems. When used in power plants, GEKO actuators are characterised by their superior tolerance with regard to voltage, vibration, and temperature and can be adapted to any mounting position required.



OIL & GAS

- > Tank farms
- > Platforms
- > Pipelines
- > Refineries
- > Pumping stations

Oil & gas are crucial energy sources for the industry. They are extracted, processed, and distributed using most sophisticated technologies and procedures. Due to the high potential hazards for people and environment, strict sets of regulations must be observed within the oil & gas sector. GEKO are renowned in this industry on an international level, complying with the increasing market demands for vendor list approvals and explosion protection certificates. GEKO actuators fully meet the requirements of the oil & gas industry with their superior SIL capability and usability under most extreme climatic conditions.

INDUSTRY

- > Heating, ventilation & air conditioning
- > Food industry
- > Chemical/pharmaceutical industry
- > Vessel and submarine ship building
- > Steel mills
- > Paper industry
- > Cement industry
- > Mining

Any process technology requires pipes and valves and consequently GEKO actuators. GEKO are in a position to supply tailor-made solutions for various plant-specific requirements. This is possible due to the modular product design.

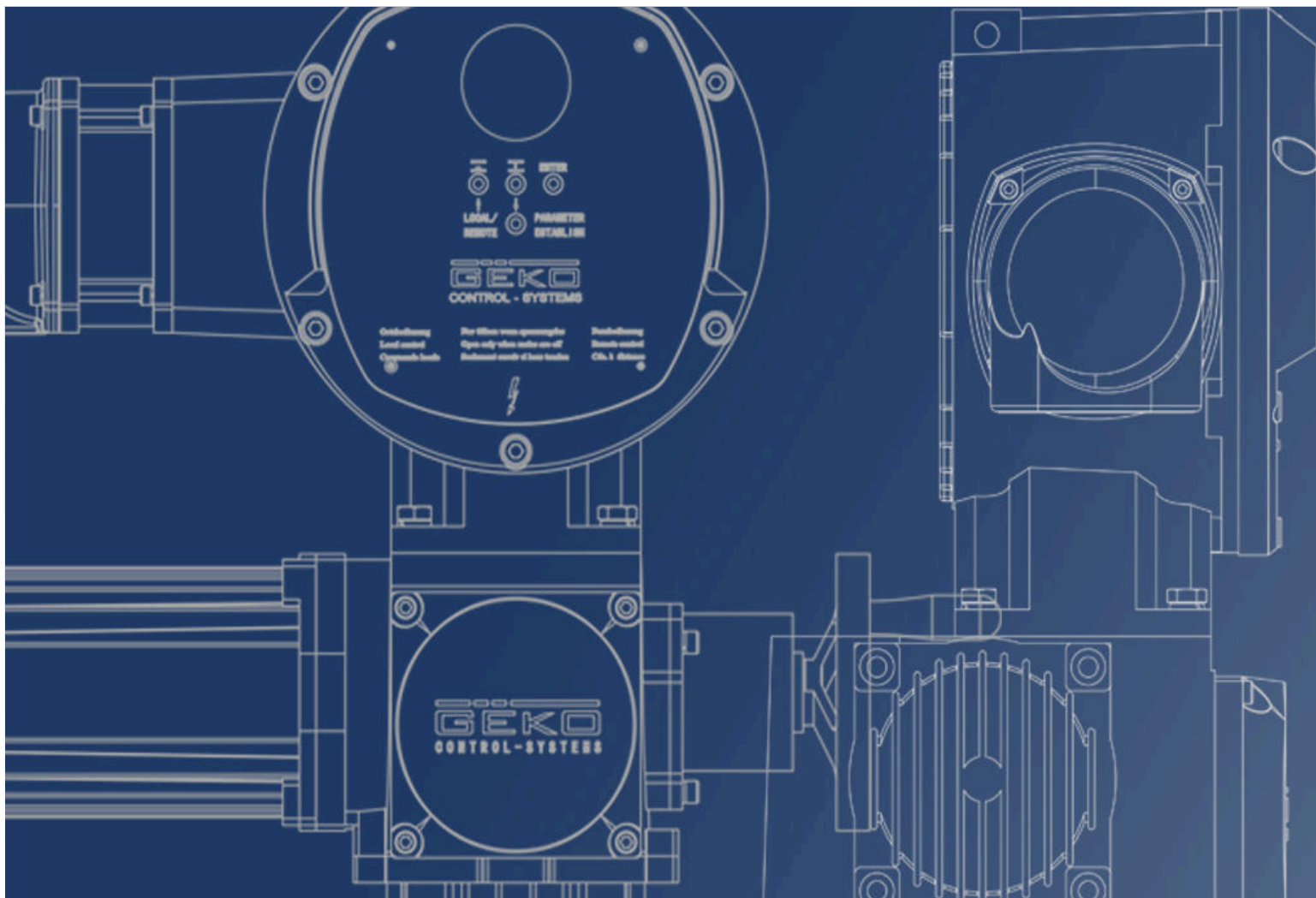

GEKO electric actuators -- outstanding advantages

1. High efficiency and energy saving, low noise

Frequency conversion intelligent actuator built-in frequency converter, so as to achieve reasonable use of energy; Because it will not open frequently when controlling, it will keep itself in a stable working state, which can make itself achieve the effect of more than 30% energy saving. At the same time, it has quite obvious effect on reducing noise and prolonging service life.

2. Powerful fault self-diagnosis function

The internal microprocessor constantly monitors the various states of the actuator, and sends out various alarms and fault information through self-diagnosis, so as to facilitate user processing and troubleshooting.

3. Enhance the protection function of the valve

As the valve reaches the end position, it can be slowed down earlier. According to the end position of the valve, the maximum output torque can be used to realize flexible valve closing and flexible starting.

4. High control precision and strong anti-drying ability

Because it uses the function of starting at the lowest speed and slowing down when it reaches the target position, it can be precisely positioned using fuzzy control technology, which can make it extremely resistant to dry.

5. It has many protection functions

The actuator can protect the motor from overheating, power phase loss, under-voltage, over-voltage, over-current and over-torque.

6. Separate installation

If the field space is not enough, the temperature is too high, the vibration is too large or it is not easy to debug, the control unit and the mechanical unit can be installed separately without affecting its performance.

7. Reduce spare parts and inventory

Because the turn-off torque and output speed can be set by the user in a wide range, spare parts are reduced.

8. Automatic detection and processing of signal faults

Under the remote control mode, the executive house will automatically detect whether the 4-20mA analog control signal circuit is normal, such as shortcircuit, short circuit and other faults, the actuator will automatically take protective measures according to the pre-set mode.

9. With a variety of configuration functions

Many features can be selected at the time of ordering.

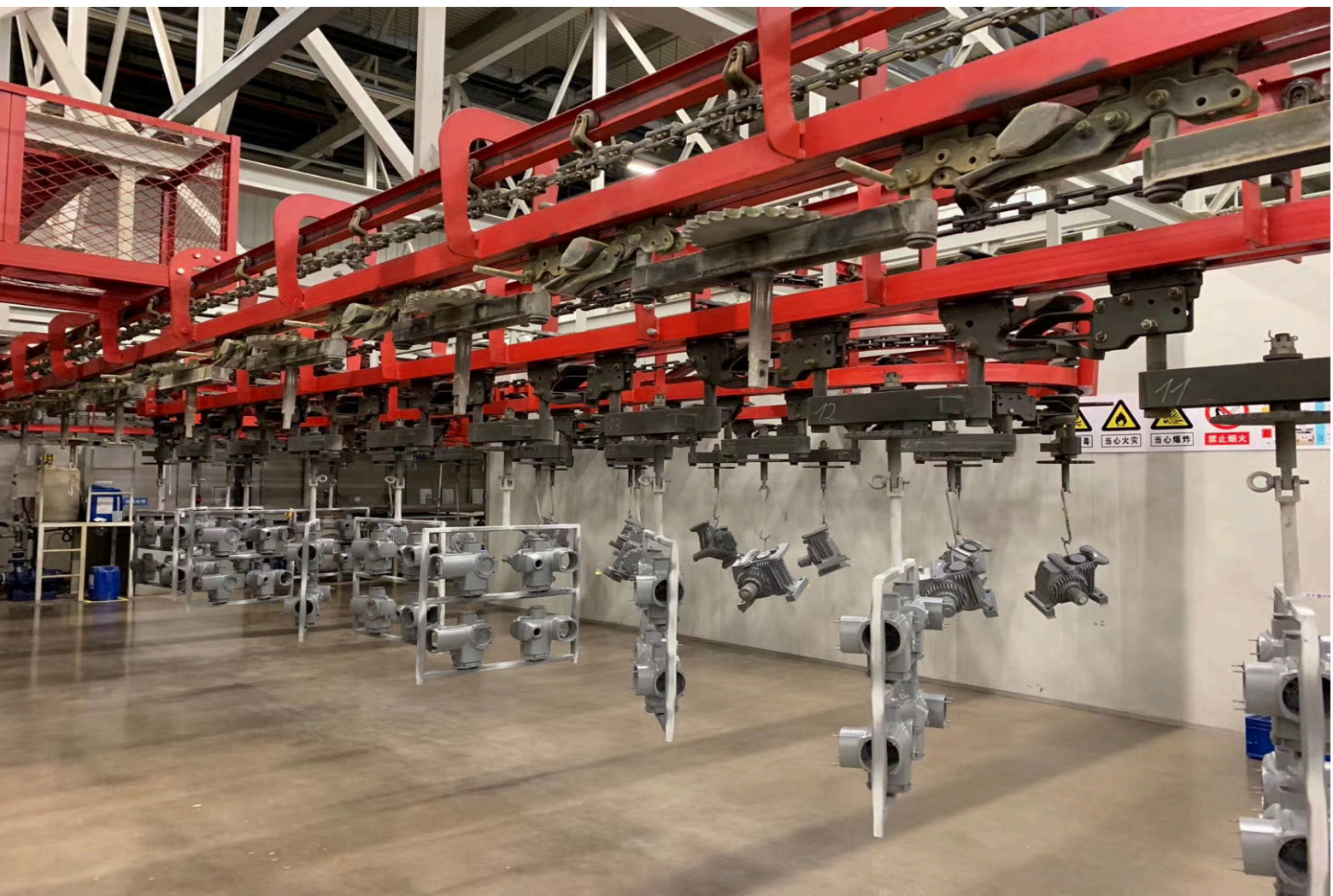

Requirement for diversity

Process engineering plants with pipe systems and valve automation are required all around the globe. Not only types of plants and valves are crucial factors for electric actuators but also the climatic conditions in which they are operated. GEKO actuators guarantee reliable and safe service under most extreme environmental conditions.







International test authorities confirm the quality of GEKO actuators designed, manufactured and tested to customer specifications by issuing product certificates.

As an independent manufacturer, GEKO can look back on long-standing experience and collaboration with the valve industry, plant engineering companies and end users of process plants in sectors such as energy, water, oil & gas, and industry.

Requirement for reliability

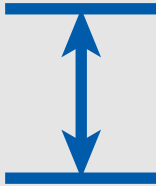
Process engineering plants are only efficient, economically viable and safe if all components involved provide reliable service during the entire lifetime. Many plants are scheduled for lifetimes of several decades. Consequently, reliable actuator service is expected during all this time. Of course, GEKO can continue to supply spare parts for types ranges which are scheduled to be discontinued for quite a long time period.

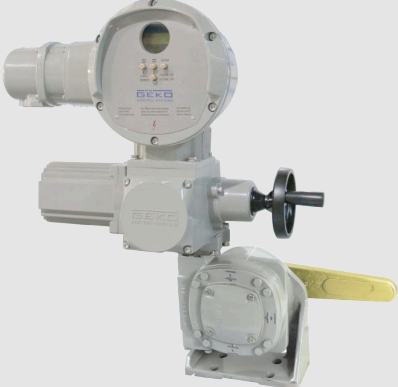
Scope of application

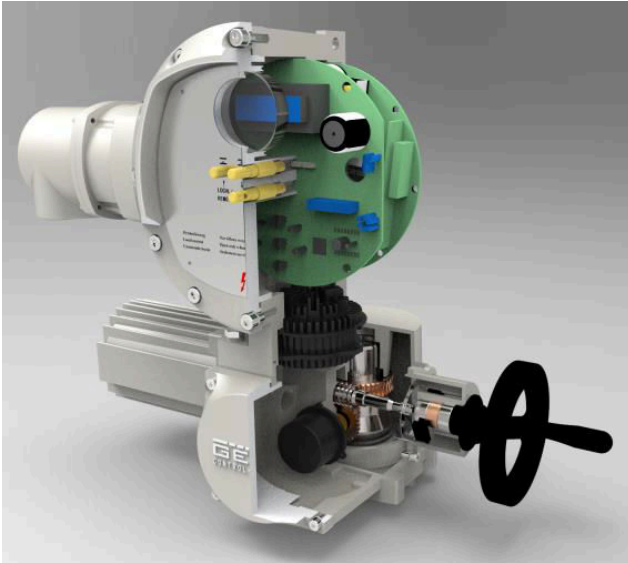

Actuator Model	Symbol	Valve Application
		<ul style="list-style-type: none"> Gate valve Globe valve Sluice valve Pinch valve
		<ul style="list-style-type: none"> Control valve Pinch valve Telescopic valve Butterfly valve with crank drive
		<ul style="list-style-type: none"> Butterfly valve Ball valve Plug valve Ventilation door Louvered vent
		<ul style="list-style-type: none"> Butterfly valve Ball valve Plug valve Ventilation door Louvered vent



★Simplify Structure, reasonable -- use electronic components instead of mechanical components, adopt modular structure.

★Protection grade: lowest level is IP67, meet the DIN EN 60529 standard. (Note: can provide IP68 protection grade when needed)

★Separate installation: when installation space not enough, the temperature is too high, the vibration is excessive or the debug and test on-site is hard, then intelligent control unit and main part can be installed separately.

LOCAL/REMOTE	<p>Short press: switch between the remote controlling mode and the on-site mode; the menu page turning when setting the mode Long press: enter or exit the parameter setting mode</p>
	<p>Local mode: the actuator operates in the forward direction Setting mode: use for parameter alteration</p>
	<p>Local mode: the actuator operates in the backward direction Setting mode: use for parameter alteration</p>
ENTER	<p>Long press: use to confirm and save after modify the parameter values</p>

Control is high reliability, flexible and optimizing—electric actuator operates from low speed to high speed and then to low speed again (curvilinear style), solving the conflict between running speed and positional accuracy, optimizing the control process.

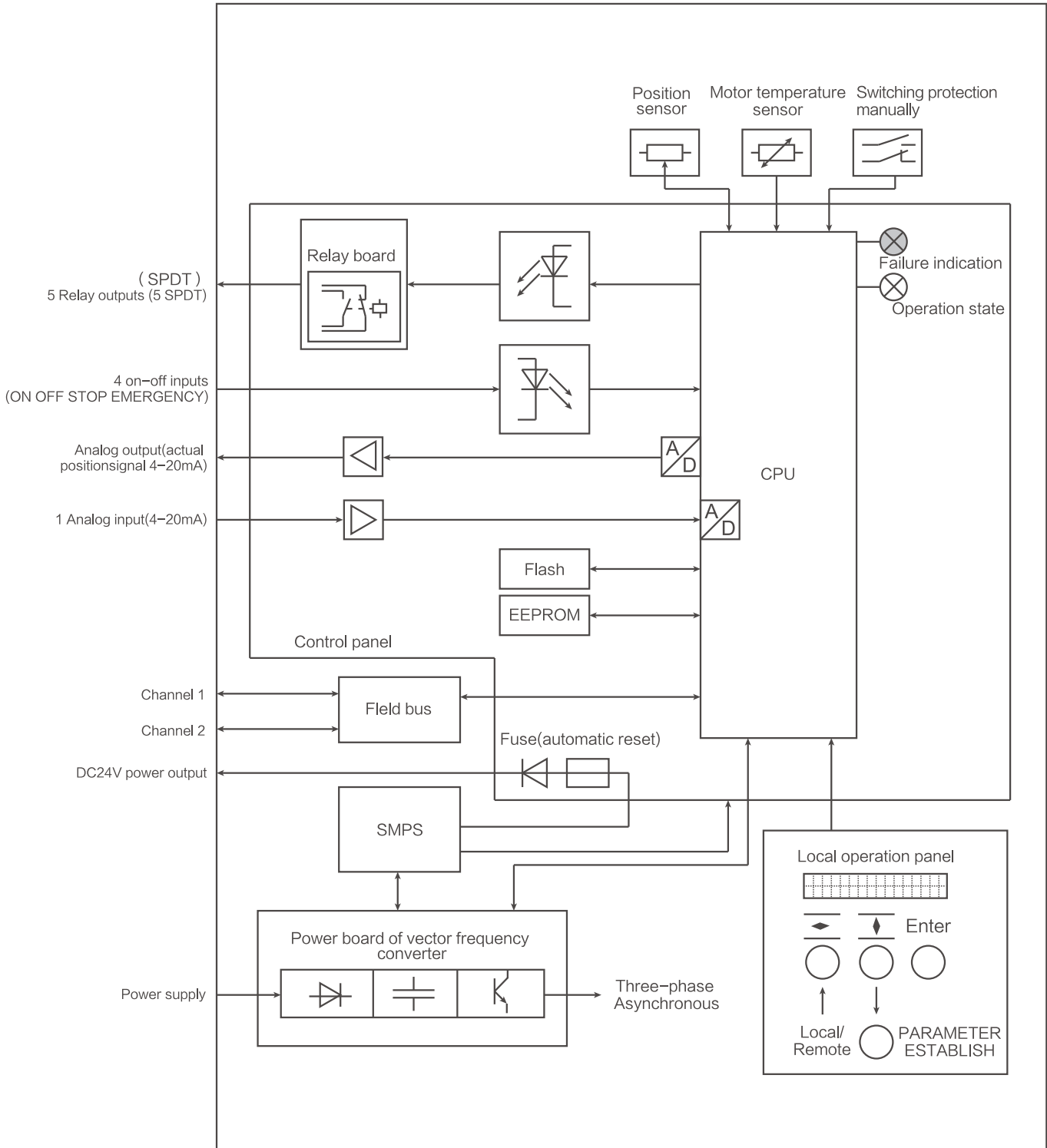

Frequency Conversion and Quick Adjustment

GKSA Series with frequency conversion control technology which can achieve quick adjustment, quick-opening and slow-closing control function.

In some cases, it requires valve control has quick adjustment and quick shutoff feature. GKSA Series Profitron adopts frequency conversion control system which can achieve valve quick adjustment and quick-opening, slow-closing control under accurate positioning.

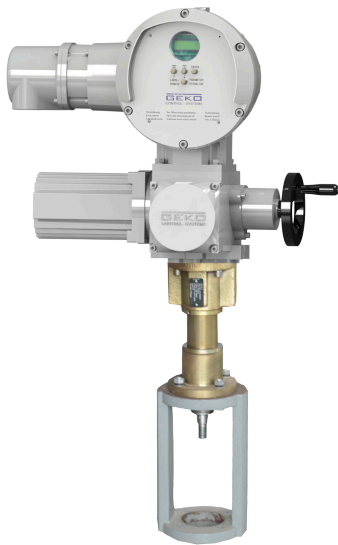

1. The fastest speed of GKSA Series linear electric actuator is 16mm/s, 10–100mm running time is 1–7s.

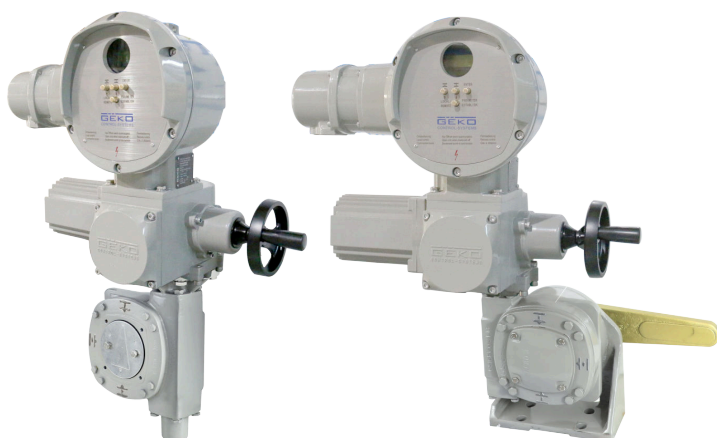

2. The entire running time of GKSA Series Quarter-turn electric actuator is 3–10s/90°



SERVICE CONDITIONS

GEKO devices are used all around the globe and are subjected to all environmental conditions for providing reliable service meeting the specified life endurance criteria.

ENCLOSURE PROTECTION

SA and SQ GEKO actuators are supplied in increased enclosure protection IP68 in compliance with EN 60529. IP68 means protection against continuous immersion up to 8 m head of water for max. 96 hours. During continuous immersion, up to 10 operations are permissible.

Typically, GEKO gearboxes are used in combination with GEKO multi-turn actuators. Gearboxes are also available in enclosure protection IP68. Certain gearboxes are intended for particular applications, e.g. buried service for part-turn gearboxes or superior immersion levels. For any special characteristics, please contact GEKO for device selection.



AMBIENT TEMPERATURES

Irrespective of the ambient environment - hot or cold - GEKO actuators guarantee reliable service. Adapted temperature versions are available to suit various ambient environments.

Type of duty	Types	Temperature range	
		Standard	Options
Open-close duty, positioning duty (classes A and B)	SA or SQ	-40 °C ... +80 °C	-60 °C ... +60 °C; 0 °C ... +120 °C
	SA or SQ with AM controls	-40 °C ... +70 °C	-60 °C ... +60 °C
	SA or SQ with AC controls	-25 °C ... +70 °C	-60 °C ... +60 °C
Modulating duty (class C)	SAR or SQR	-40 °C ... +60 °C	-40 °C ... +80 °C -60 °C ... +60 °C
	SAR or SQR with AM controls	-40 °C ... +60 °C	-40 °C ... +70 °C -60 °C ... +60 °C
	SAR or SQR with AC controls	-25 °C ... +60 °C	-25 °C ... +70 °C -60 °C ... +60 °C

Further temperature ranges on request

The efficient GEKO corrosion protection is decisive for a high life endurance level of the devices. The GEKO corrosion protection system is based on a chemical preliminary treatment, followed by a two-layer powder coating of the individual components. In compliance with the corrosivity categories according to EN ISO 12944-2, various GEKO corrosion protection levels are provided to suit the different applications.

Colour

The standard colour is silver-grey (similar to RAL 7037). Other colours are available.

Corrosivity categories according to EN ISO 12944-2 Classification of environments		SA, SQ actuators and AM, AC controls	
		Corrosion protection class	Total film thickness
C1 (very low):	Heated buildings with clean atmospheres	KS	140 µm
C2 (low):	Unheated buildings and rural areas with low level of pollution		
C3 (medium):	Production rooms with humidity and some air pollution. Urban and industrial atmospheres with moderate sulphur dioxide pollution		
C4 (high):	Chemical plants and areas with moderate salinity		
C5-I (very high, industrial):	Industrial areas with almost permanent condensation and with high pollution.		
C5-M (very high, marine):	Coastal and offshore areas with high salinity, almost permanent condensation and with high pollution.		
Corrosivity categories for requirements beyond EN ISO 12944-2			
Extreme (cooling tower):	Coastal and offshore areas with extremely high salinity, permanent condensation and high pollution	KX KX-G (aluminium-free)	200 µm

The GEKO corrosion protection system is certified by TÜV Rheinland.

SERVICE CONDITIONS



POWDER COATING - COATING STRUCTURE

Housing

Conversion layer

Functional coating to increase paint adherence to the housing surface.

First powder layer

Powder layer based on epoxy resin. The layer ensures optimal adherence between housing surface and finish coating.

Second powder layer

Powder layer based on polyurethane. The layer is a resistance barrier against chemicals and weathering. The optimal degree of cross-linking of the cured powder results in a significant mechanical resistance. The standard colour is GEKO silver-grey, similar to RAL 7037.



EXPLOSION PROTECTION

Explosion-proof devices are designed so that they will not act as ignition source for a potentially explosive atmosphere. They will neither generate sparks nor hot surfaces.

For further classifications, please refer to the brochure “Electric actuators for the automation of valves in the oil and gas industry”.

Explosion protection classification for Europe and in accordance with international IEC standard (selection)

Actuators	Ambient temperature range		Explosion protection
	min.	max.	
Europe - ATEX			
Multi-turn actuators GKSAEx/SAREx 07.2 – 16.2	-20 ° C	+60 ° C	Ex de IIC T4/T3 Gb; Ex d IIC T4/T3 Gb
Multi-turn actuators GKSAEx/SAREx 07.2 – 16.2 with AMExC or ACExC	-20 ° C	+60 ° C	Ex de IIC T4/T3 Gb; Ex d IIC T4/T3 Gb
Part-turn actuators GKSGExC 05.1 – 12.1	-50 ° C	+60 ° C	Ex de IIC T4; Ex d IIC T4
Part-turn actuators GKSGExC 05.1 – 12.1 with AMExC or ACExC	-50 ° C	+60 ° C	Ex de IIC T4; Ex d IIC T4
International/Australia - IECEx			
Multi-turn actuators GKSAEx/SAREx 07.2 – 16.2	-60 ° C	+60 ° C	Ex de IIC T4/T3 Gb; Ex d IIC T4/T3 Gb
Multi-turn actuators GKSAEx/SAREx 07.2 – 16.2 with AMExC or ACExC	-60 ° C	+60 ° C	Ex de IIC T4/T3 Gb; Ex d IIC T4/T3 Gb
Multi-turn actuators GKSAEx/SAREx 25.1 – 40.1	-20 ° C	+60 ° C	Ex ed IIB T4 Gb
Part-turn actuators GKSQEx/SQREx 05.2 – 14.2	-60 ° C	+60 ° C	Ex de IIC T4/T3 Gb; II 2 G Ex d IIC T4/T3 Gb
Part-turn actuators GKSQEx/SQREx 05.2 – 14.2 with AMExC or ACExC	-60 ° C	+60 ° C	Ex de IIC T4/T3 Gb; II 2 G Ex d IIC T4/T3 Gb



COMMUNICATION - TAILOR-MADE INTERFACES

The mechanical interface to the valve is standardised. Interfaces to the control system undergo permanent development.

Parallel control, fieldbus, or both for reasons of redundancy?
When opting for fieldbus, which protocol to use?

Irrespective of your decision on the interface, GEKO actuators can be equipped with the suitable interface to match all systems established within process control engineering.

Actuator commands and signals

In simple applications, operation commands OPEN and CLOSE, feedback signals End position OPEN/End position CLOSED reached as well as Collective fault signal suffice. Any isolating valve can be reliably operated with these five discrete signals.

However, if the valve position is to be controlled, further continuous signals are required: Position setpoint and position feedback signal (actual value), typically a 4 – 20 mA analogue signal for parallel communication.

Fieldbus protocols expand the bandwidth for information transmission. Further to transmission of commands and feedback signals required for operation, access to all device parameters and operating data via fieldbus from the DCS is made available.

AM

All inputs and outputs are hard wired, as detailed on the terminal plan.

> Three binary inputs for the control commands OPEN, STOP, CLOSE

> Five binary outputs with the following functions: End position CLOSED, end position OPEN, selector switch in REMOTE, selector switch in LOCAL, collective fault signal

> As an option, an analogue 0/4 – 20 mA output for remote position indication.

The binary inputs and outputs are potential-free, the analogue output is galvanically isolated.

AC

Signal assignment of outputs can be modified at a later date via AC device setting. Depending on the version, AC controls provide:

> Up to six binary inputs
e.g. operation commands OPEN, STOP, CLOSE, enable signals for local controls, EMERGENCY commands, etc.

> Up to ten binary outputs
e.g. for feedback of end positions, intermediate positions, selector switch position, failures, etc.

> Up to two analogue inputs (0/4 – 20 mA)
e.g. for setpoint reception to control the positioner or PID controller

> Up to two analogue outputs (0/4 – 20 mA)
e.g. for feedback of valve position or torque

The binary inputs and outputs are potential-free, analogue outputs are galvanically isolated.

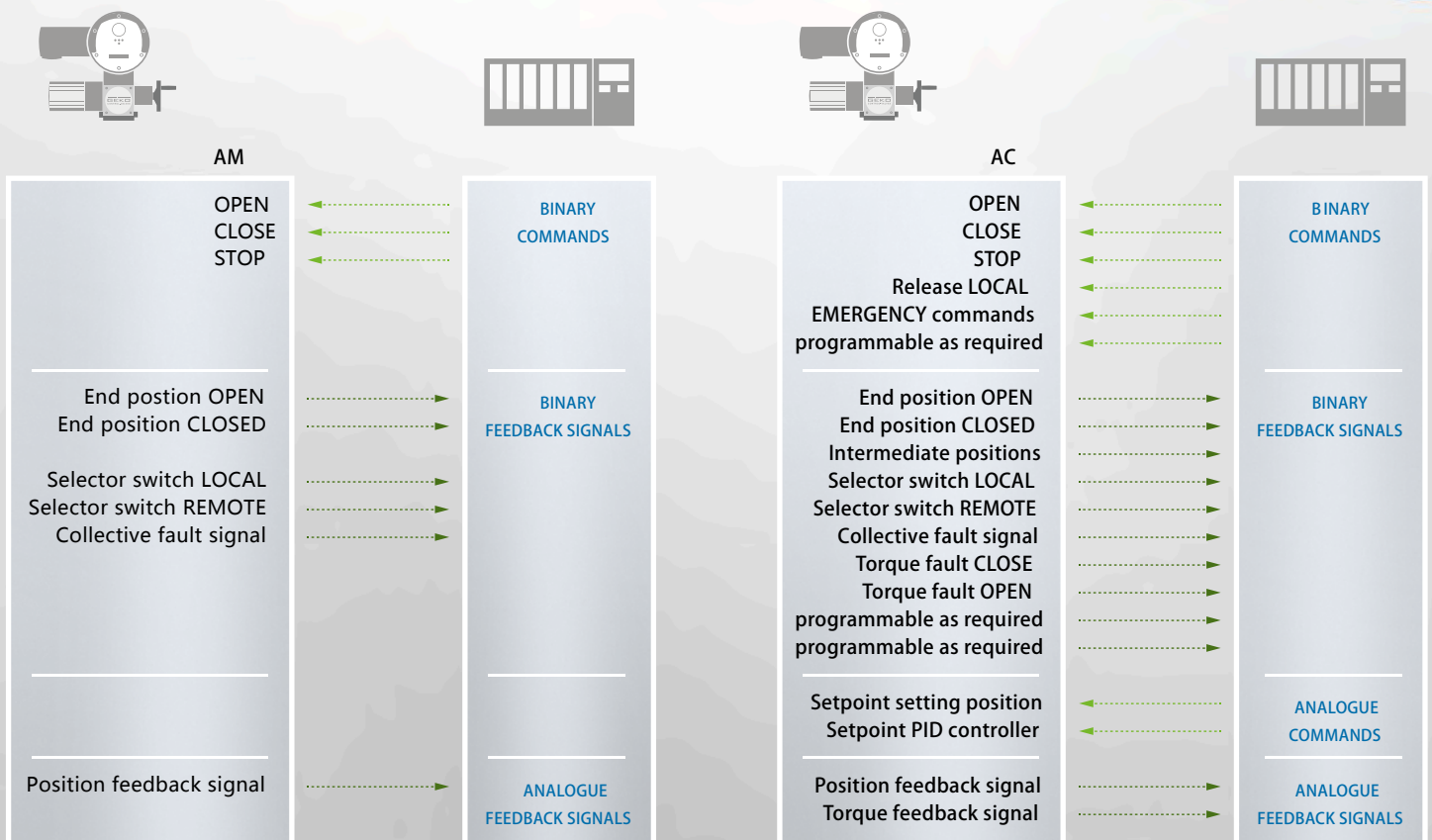



COMMUNICATION - FIELDBUS

Cost reduction is one of the main factors in favour of fieldbus technology. In addition, introduction of serial communication in process automation has proven as an innovation driver for field devices and consequently for actuators. Concepts for efficiency gains such as remote parameterisation or Plant Asset Management would not be feasible without fieldbus technology. GEKO actuators equipped with fieldbus interfaces are state of the art.

GEKO fieldbus devices

Many different fieldbus systems are available on the market. Certain preferences have evolved on a regional level or specific to certain plant applications. Since GEKO actuators are implemented in all types of process plants around the globe, they are available with any fieldbus system established in this industry.

- > Profibus DP
- > Modbus RTU
- > Foundation Fieldbus
- > HART

Overall, GEKO devices are available with binary and analogue inputs to connect additional sensors to the fieldbus.

Profibus offers a complete family of fieldbus versions: Profibus PA for process automation, Profinet for data transmission based on Ethernet and Profibus DP for automating plants, power plants and machines. Due to its simple and robust physical layer (RS-485) and the different service levels DP-V0 (fast cyclic and deterministic data exchange), DP-V1 (acyclic access to device parameters and diagnostic data) as well as DP-V2 (further functions such as time stamp or redundancy), Profibus DP is the ideal solution for plant automation.

- > International standard, IEC 61158/61784 (CPF3), www.profibus.com
- > Large installation base
- > Standardised integration within the DCS (FDT, EDD)
- > Large selection of devices
- > Typical applications: Power plants, sewage treatment plants, water treatment plants, tank farms

GEKO actuators with Profi bus DP

- > Support Profibus DP-V0, DP-V1 and DP-V2
- > High speed data exchange (up to 1.5 Mbit/s - corresponds to approx. 0.3 ms/actuator)
- > Integration within the DCS via FDT or EDD (please also refer to page 39)
- > Cable length up to approx. 10 km (without repeater up to 1,200 m)
- > Up to 126 devices can be connected
- > Option: Redundant line topology as an
- > Option: Data transmission via fibre optic cables (refer to page 43)
- > Option: Overvoltage protection up to 4 kV

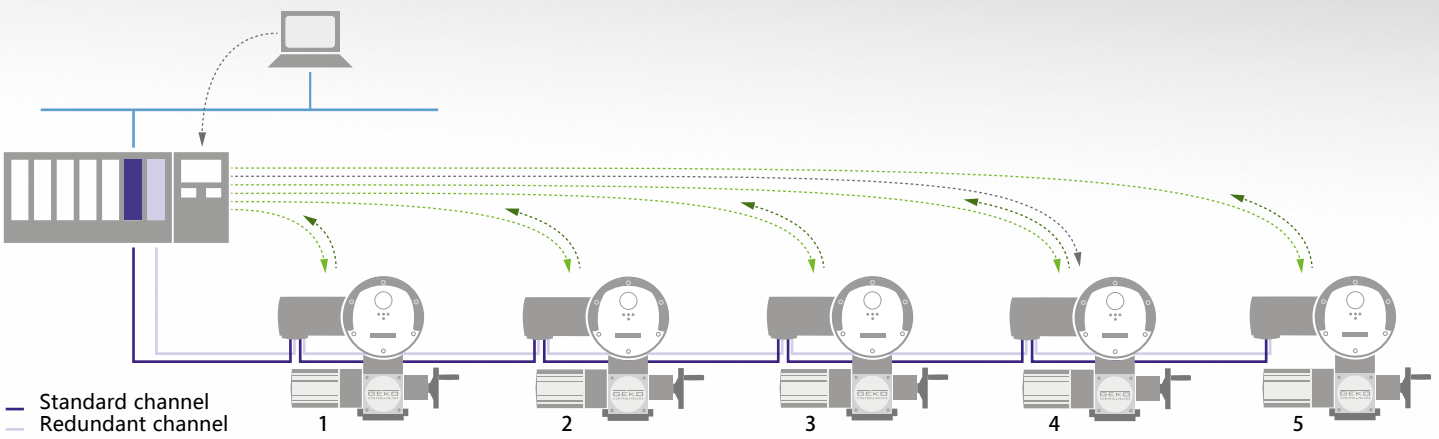

Bus cycle with 5 actuators

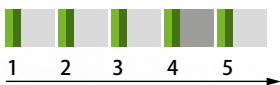

- Cyclic process data request from master
- Cyclic process data feedback from slave
- Acyclic diagnostic or parameter data transmission

Comparison of bus cycle times

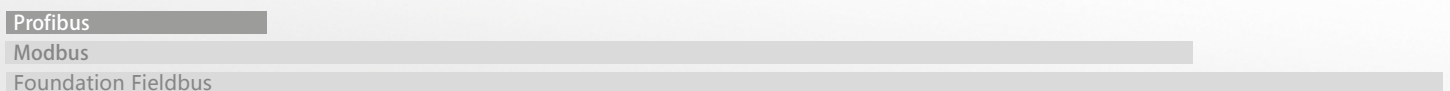

In comparison with other fieldbus technologies, Modbus is simple but has a multi-functional fieldbus protocol. It offers all services required for plant automation, e.g. exchange of simple, binary information, analogue values, device parameters or diagnostic data.

For plant automation and similar to Profibus, the simple and robust physical layer RS-485 is often used.

On the basis of this physical layer, Modbus supports various telegram formats, e.g. Modbus RTU or Modbus ASCII. Using the Modbus TCP/IP version based on Ethernet, vertical integration into a host automation system is often implemented.

GEKO actuators and Modbus RTU

- > Fast data exchange (up to 115.2 kbit/s - corresponds to approx. 20 ms/actuator)
- > Cable length up to approx. 10 km (without repeater up to 1,200 m)
- > Up to 247 devices can be connected
- > Option: Redundant line topology
- > Option: Data transmission via fibre optic cables (refer to page 43)
- > Option: Overvoltage protection up to 4 kV

- > International standard, IEC 61158/61784 (CPF15), www.modbus.org
- > Simple protocol
- > Worldwide distribution
- > Largely sufficient for many simple automation tasks
- > Typical applications: Water and wastewater treatment plants, pumping stations, tank farms

COMMUNICATION - FIELDBUS

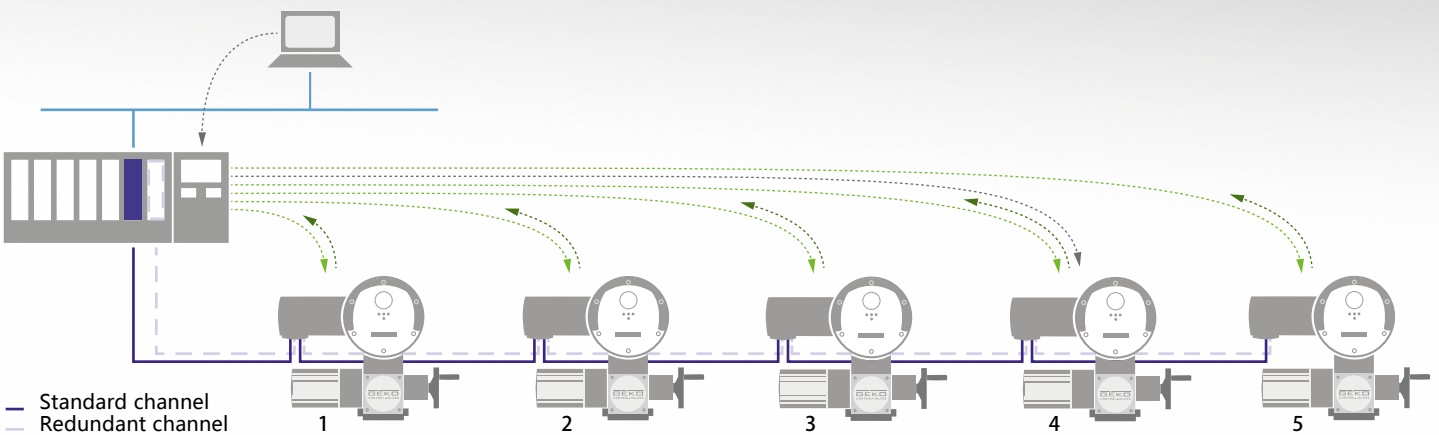

Bus cycle with 5 actuators



- Cyclic process data request from master
- Cyclic process data feedback from slave
- Acyclic diagnostic or parameter data transmission

Comparison of bus cycle times

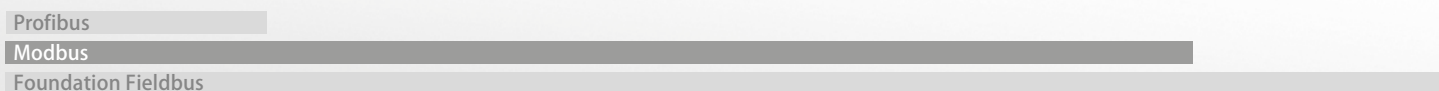

Foundation Fieldbus (FF) was explicitly adapted to the requirements of process automation. Transmission physics of the FF H1 protocol used at field level are based on IEC 61158-2 and ISA SP 50.02. These standards define the framework for data transmission and energy supply of simple field devices using the same cable pair. FF H1 supports various topologies. In combination with junction boxes or segment barriers, extremely flexible cable installations are possible. Apart from conventional line and tree structures, FF H1 supports point-to-point topology or other structures with one trunk combined with individual spurs leading to the field devices.

Foundation Fieldbus data interfaces are based on standardised function blocks, for example AI (Analog Input), or AO (Analog Output) whereby their inputs and outputs can be linked. Therefore, FF fieldbus devices can directly communicate with each other provided that the segment is equipped with a Link Active Scheduler (LAS) to coordinate FF communication.

GEKO actuators and Foundation Fieldbus

GEKO actuators support FF H1 version.

- > Data exchange at 31.25 kbit/s, typical cycle time 1s
- > Cable length up to approx. 9.5 km (without repeater up to 1,900 m)
- > Up to 240 devices can be addressed, typically 12 to 16 field devices are available
- > Integration within the DCS via DD or FDT (please also refer to page 39)
- > GEKO actuators support LAS and thus adopt the tasks of the link active scheduler.
- > Option: Overvoltage protection up to 4 kV

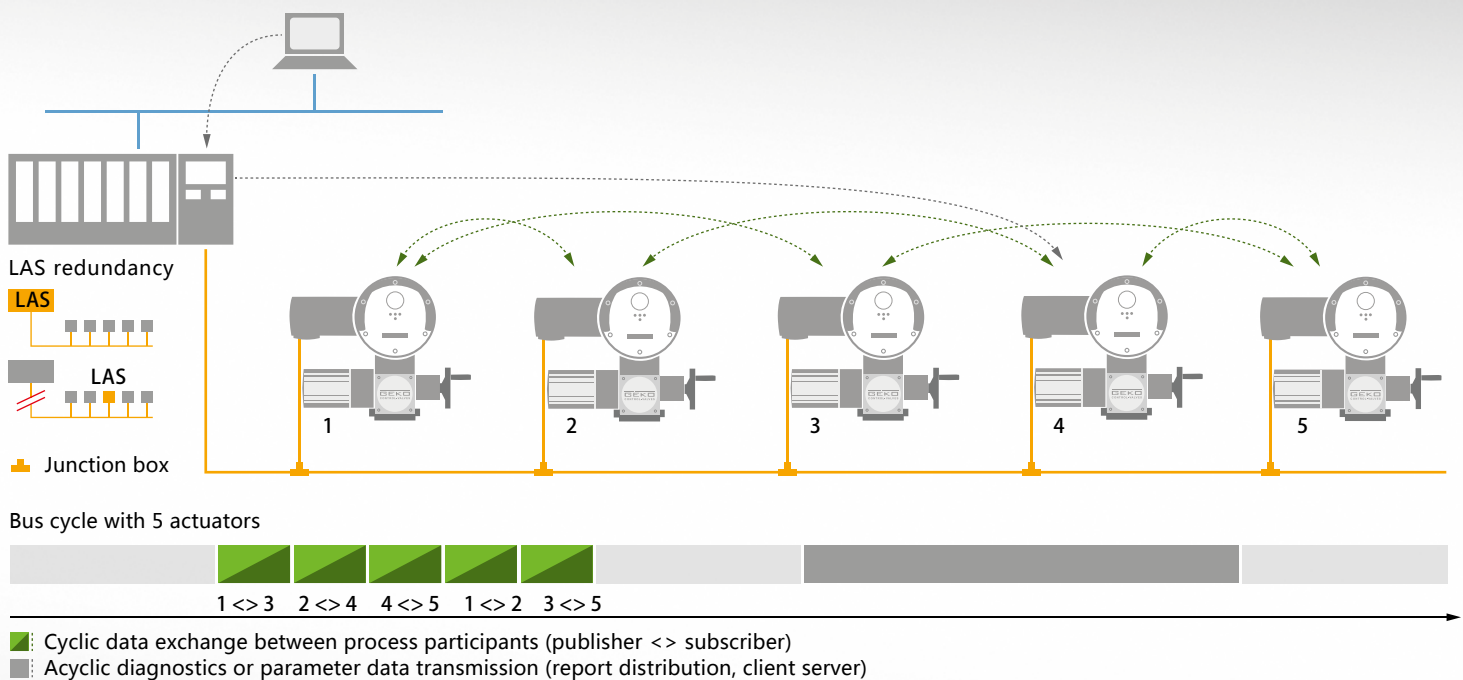

Comparison of bus cycle times

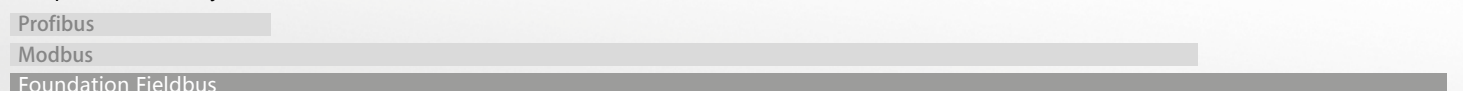

HART makes use of the known 4 – 20 mA standard signal for analogue data transmission. HART communication is modulated as additional signal to the analogue signal.

Advantages: Simultaneous transmission of the digital and the analogue HART signals. Existing 4– 20 mA infrastructure is also available for digital communication. Facilitates reading additional parameter and diagnostic data from field devices.

HART uses the master-slave principle and offers various commands for data transmission. Normally, the conventional 4 – 20 mA point-to-point wiring is used.

- > International standard IEC 61158/61784 (CPF9)
- > Worldwide distribution
- > Large installation base
- > Standardised integration within the DCS (FDT, EDD)
- > Large selection of devices

GEKO actuators with HART

- > 4 – 20 mA HART analogue signal either for setpoint transmission or alternatively to communicate the actual position.
- > Transmission of parameter and diagnostic data via digital HART communication
- > approx. 500 ms per actuator for digital communication
- > Integration within the DCS via EDDL (please also refer to page 39)
- > Length of cable approx. 3 km

COMMUNICATION - HART

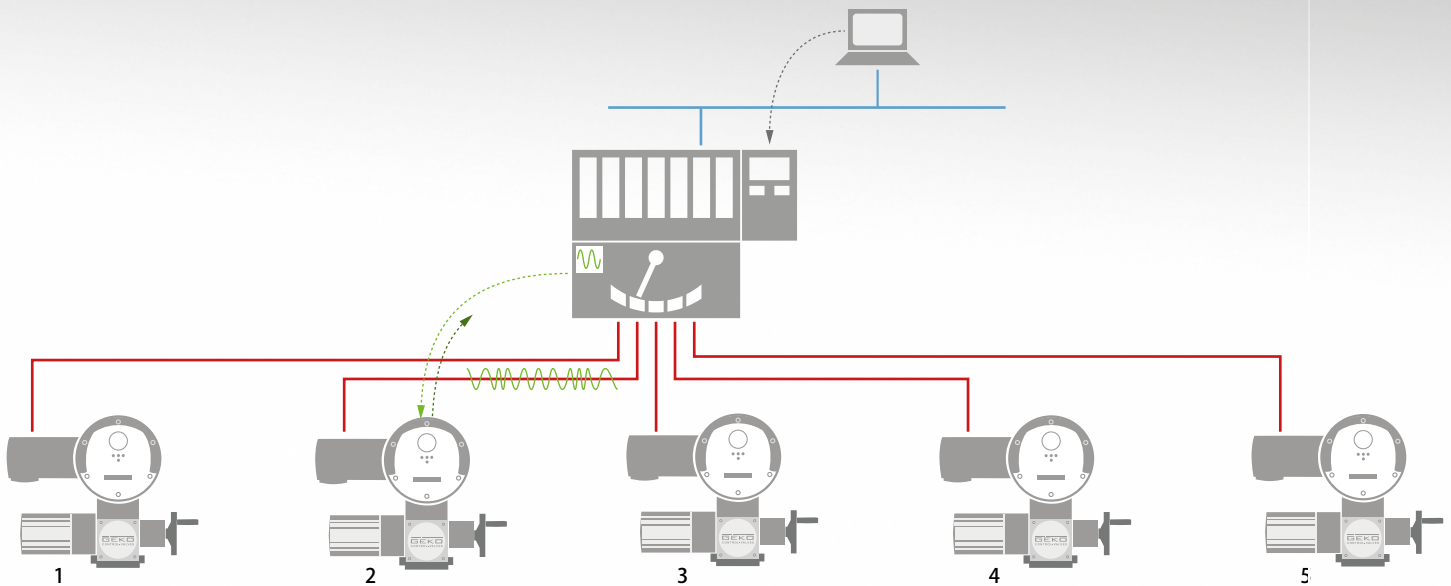

— Conventional 4 – 20 mA signal cable
 ~ Digital HART communication

Cycle with 5 actuators

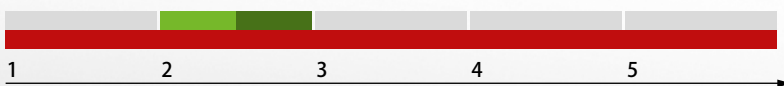

■ Parameter or diagnostic data request from master
 ■ Parameter or diagnostic data feedback from slave
 ■ Analogue process signal

EDD and FDT/DTM are two independent technologies for harmonisation of device integration within fieldbus systems across all field devices. This includes for example device configuration, device replacement, fault analysis, device diagnostics, or documentation of these actions. For this reason, EDD and FDT/DTM are crucial for Plant Asset Management and Lifecycle Management of a plant.

Besides the imperative main functions, field devices possess diagnostic functions and many specialised application functions to adapt the device to the process and environmental conditions as required. If certain prerequisites are fulfilled, e.g. DP-V1 protocol for Profibus, data exchange connected to these functions can directly take place between control station and field device via fieldbus. For GEKO actuators, this further includes status and diagnostic signals in compliance with NAMUR NE 107, parameter modifications of user functions, information of the electronic device ID or operational data for preventive maintenance.

EDD or FDT/DTM is used to harmonise access from the control station to the data available with the various field devices.

EDD

Each field device supporting this technology is provided with an EDD (Electronic Device Description). This file combines device parameters described in ASCII using standardised and platform neutral EDD language. The technology helps to create a uniform user philosophy with identical parameter visualisation across all field devices.

FDT/DTM

FDT (Field Device Tool) is a software interface definition to integrate DTM (Device Type Manager) into the FDT system of the maintenance processor. DTM is a software module supplied by field device manufacturers. Similar to a printer driver, DTM is installed within the FDT frame application to visualise settings and information available from the field devices.

You may download available EDDs and DTMs for GEKO actuators at: www.geko-valves.de

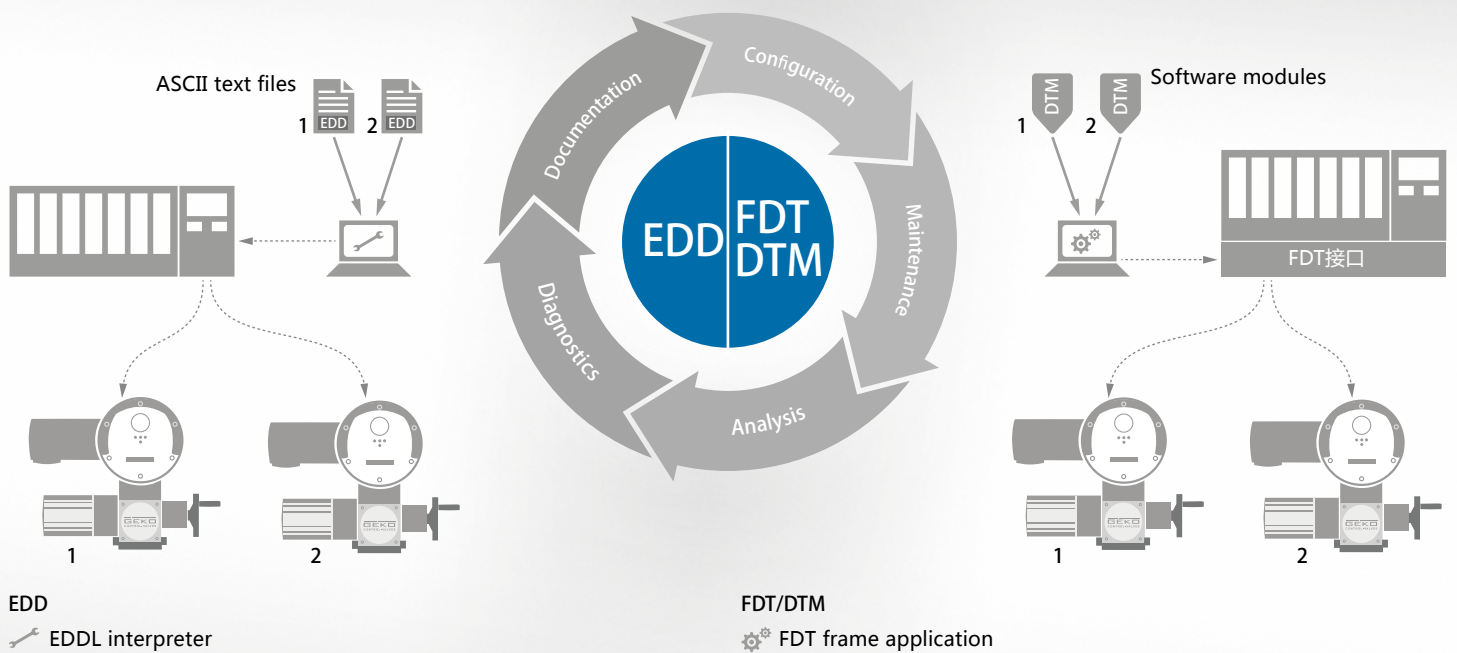

Comparison of functional scope

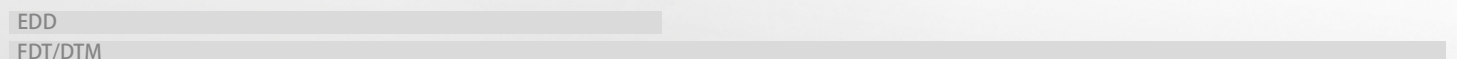



SIMA - THE FIELDBUS SYSTEM SOLUTION

SIMA is the ideal master station for perfect integration of actuators into a DCS. Entire communication is based on open fieldbus protocols.

- > SIMA supports the user with a mostly automated procedure for commissioning the connected actuator network, irrespective of the DCS - plug and play.
- > SIMA manages communication to field devices including all redundant data channels and hot standby components.
- > SIMA as data concentrator collects all actuator status signals and sends the signals relevant for normal service to the DCS.
- > SIMA facilitates status information access to the connected actuators.
- > In the event of failures, SIMA supports fast fault identification and remedy.
- > SIMA serves the purpose of gateway to adapt fieldbus communication with actuators to the available interfaces of the DCS.

Configuration interface

Various SIMA equipment features offer different access options for operation and configuration. This includes an integrated touch screen, connection facilities for a mouse, keyboard and external screen or Ethernet interface for SIMA integration into an available network.

Graphic elements provide overall system visualisation at a glance. Settings and configurations are password protected for different user levels.

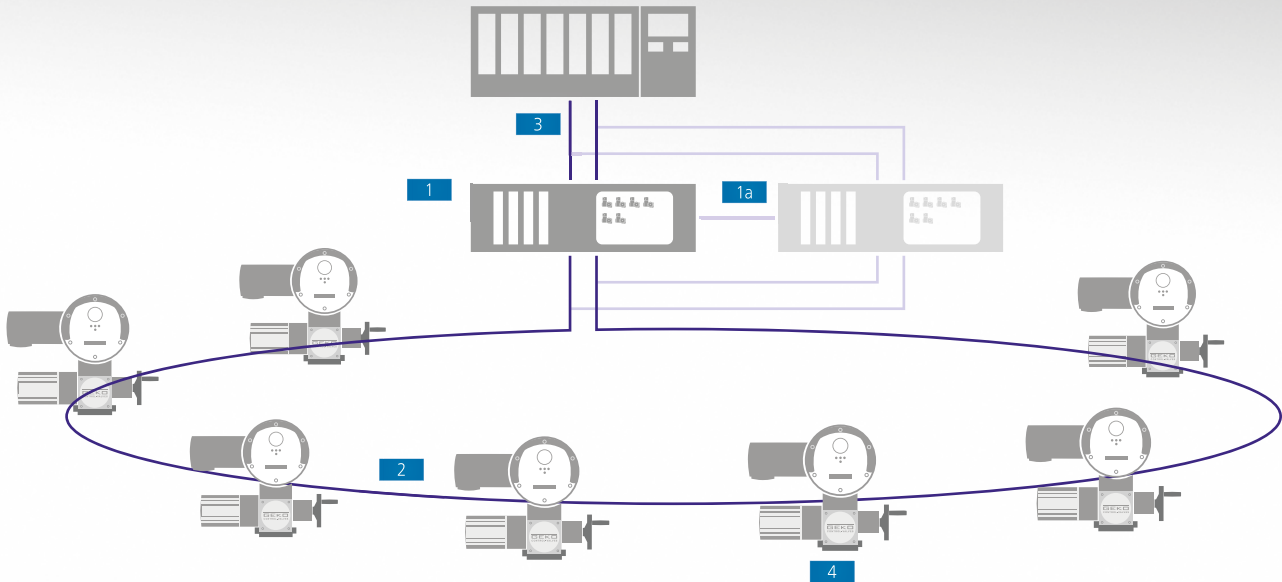

Redundancy within loop

Communication without fault Communication in the event of fault

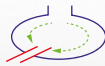

Comparison of max. cable lengths of fieldbus systems

without SIMA 10 km

with SIMA

296 km

1 SIMA Master Station

SIMA combines standardised industrial PC components extended by required fieldbus interfaces. The entire hardware is housed in a robust 19" industrial enclosure with EMC protection.

1a Hot standby SIMA

Increased availability and reliability can be achieved by installing a backup SIMA, taking over all tasks of the primary SIMA in case of failure.

2 Redundant Modbus loop

The major advantage of this topology is the integrated redundancy. If the loop is interrupted, SIMA considers both segments as separate lines and all actuators remain accessible. Actuators selected for this topology are equipped with a repeater function for galvanic isolation of loop segments and for Modbus signal amplification. As a consequence, a total length of up to 296 km can be achieved using a conventional RS-485 cable with maximum 247 participants.

It is also possible to implement line topologies with SIMA.

3 Communication with DCS

DCS communication is possible using Modbus RTU or Modbus TCP/IP.

4 GEKO actuators

GEKO actuators are equipped with the suitable interface matching selected fieldbus protocol and topology. Individual devices can be separated from the fieldbus without interrupting fieldbus communication to other devices.

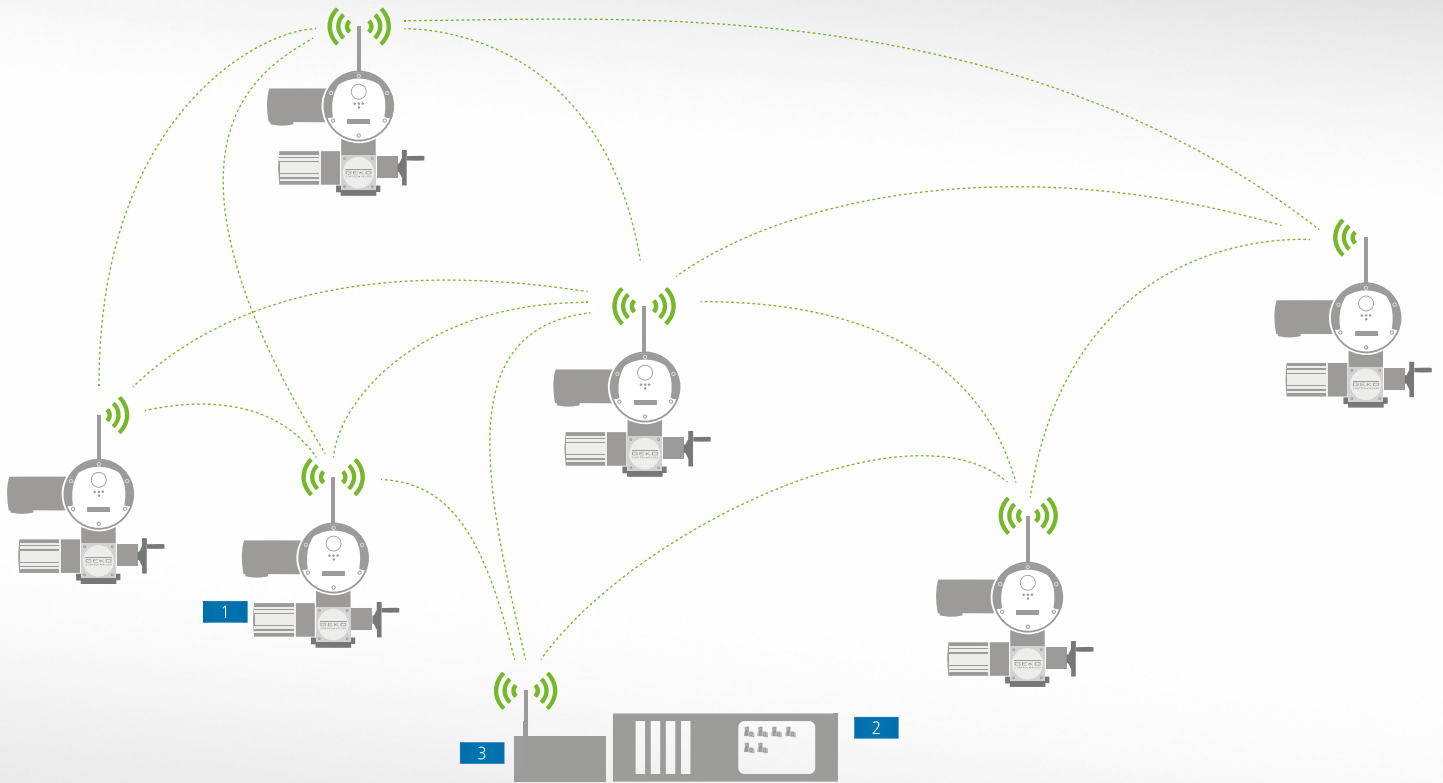

ALTERNATIVE COMMUNICATION CHANNELS - WIRELESS AND FIBRE OPTIC CABLES

The use of copper cables can be unsatisfactory for certain applications. Here, it is possible to switch to fibre optic cables. When selecting Wireless, communication is made without cables.

WIRELESS

Further advantages other than obsolete wiring: Fast commissioning and easy system extension. Each participant can communicate within the own radio range. This mesh topology increases availability through redundant communication. If one participant or a radio connection fails, an alternative communication path is automatically adopted.

The Wireless solution is a variant of the SIMA system solution, enhancing to a large extent of the functions as mentioned on page 40.

Radio transmission is based on wireless communication standard IEEE 802.15.4 (at 2.4 GHz). AES-128-bit encryption is used to protect data transfer and parameterisation of field devices for communication.

1 GEKO actuators with Wireless interface

2 SIMA Master Station

SIMA described on page 40 coordinates communication to the field devices in cooperation with the gateway.

3 Wireless gateway

The gateway establishes access to the SIMA Wireless system and comprises the network manager and the security manager.

Application examples



Tunnel fire protection



Sewage treatment plant lightning protection

Comparison of max. distances between bus participants

Copper cable 1.2 km

FO multi-mode 2.5 km

FO single-mode 15 km

DATA TRANSMISSION VIA FIBRE OPTIC CABLES

Long distances between the devices combined with the high demands for data transmission security - in this instance, fibre optic cables (FO) are a suited transmission medium.

Long distances

Low attenuation of light signals in fibre optic cables allows coverage of long distances between participants, resulting in a considerably higher total fieldbus system length. When using multi-mode fibres, distances can reach up to 2.6 km between the devices. For single-mode fibres, this can still be up to 15 km.

Integral overvoltage protection

Contrary to copper cables, fibre optic cables are resistant to electromagnetic interference. Separated installation of signal cables and power cables is no longer required. Fibre optic cables provide galvanic isolation between actuators. This offers particular protection against overvoltages, for example in the event of lightning.

GEKO actuators with fibre optic interface (FO)

FO module for converting actuator-internal electrical signals into fibre optic signals is integrated within the electrical connection of the actuator. Connection of fibre optic cables is made via conventional FSMA plug/socket connectors.

In combination with Modbus RTU, FO cable systems in both line and star topology can be implemented. When using Profibus DP, ring topology is also possible. In this case, the availability of the fibre optic ring is monitored. If the ring is interrupted, a warning will be sent. This warning is integrated within the signalling pattern of AC actuator controls, visualised on the display and transmitted to the control station in compliance with the specified signalling pattern.



Conventional type



Explosion-proof type

GKSA···Series multi-turn electric actuators technical data

Type	Adjustable tripping torque (Nm)	Maximum rotation	Output speed (r/min)	Flange size
GKSA10.5/GKSA10.0	9-30	0.8-4020	5-40/10-80/20-160	F07
GKSA11.5/GKSA11.0	9-30	0.8-4020	5-40/10-80/20-160	F10
GKSA21.5/GKSA21.0	18-60	0.8-4020	5-40/10-80/20-160	F10
GKSA31.5/GKSA31.0	37-125	0.8-4020	5-40/10-80/20-160	F10
GKSA32.5/GKSA32.0	37-125	0.8-4020	5-40/10-80/20-160	F12
GKSA33.5/GKSA33.0	75-250	0.8-4020	5-40/10-80/20-160	F14
GKSA42.5/GKSA42.0	75-250	0.8-4020	5-40/10-80/20-160	F12
GKSA43.5/GKSA43.0	75-250	0.8-4020	5-40/10-80/20-160	F14
GKSA53.5/GKSA53.0	150-500	0.8-4020	5-40/10-80/20-160	F14
GKSA54.5/GKSA54.0	150-500	0.8-4020	5-40/10-80/20-160	F16
GKSA64.5/GKSA64.0	300-1000	0.8-4020	5-40/10-80	F16
GKSA75.5/GKSA75.0	600-2000	0.4-2010	2.5-20/5-28	F25
GKSA86.5/GKSA86.0	1200-4000	0.2-1005	1.25-10/2.5-20	F30



GST...Series multi-turn reduction gear box



GK...Series multi-turn reduction gear box

GST...Series multi-turn reduction gear box technical data

Type	Reduction ratio	Output torque (Nm)	Input torque (Nm)	Input flange	Output flange (JB2920)	Magnification	Weight (Kg)
GST04	2.5:1	675	340	F14	4	2	13
GST05	6:1	1350	270	F14	5	5	22
GST07	3.8:1	3000	1000	F16	7	3	60
GST07	3:1	3000	1200	F16	7	2.5	60
GST08	3.5:1	6000	2100	F16	8	2.8	68

GK...Series rotary reduction gear box of technical data

Type	Reduction ratio	Output torque (Nm)	Input torque (Nm)	Input flange	Output flange (JB2920)		Magnification	Weight (Kg)
					ISO5210	JB2920		
GK10.2	4:1	120	34	F10	F10	2	3.6	13
GK14.2	4:1	250	70	F14	F14	3	3.6	14
GK14.6	4:1	500	139	F14	F14	4	3.6	18
GK16.2	4:1	1000	278	F16	F16	5	3.6	33
GK16.2	6:1	1000	200	F16	F16	5	5	35
GK25.2	4:1	2000	556	F25	F25	7	3.6	56
GK25.2	6:1	2000	400	F25	F25	7	5	58
GK30.2	4:1	4000	1112	F30	F30	8	3.6	85
GK35.2	4:1	8000	2224	F35	F35	9	3.6	120
GK40.2	4:1	16000	4448	F40	F40	10	3.6	330

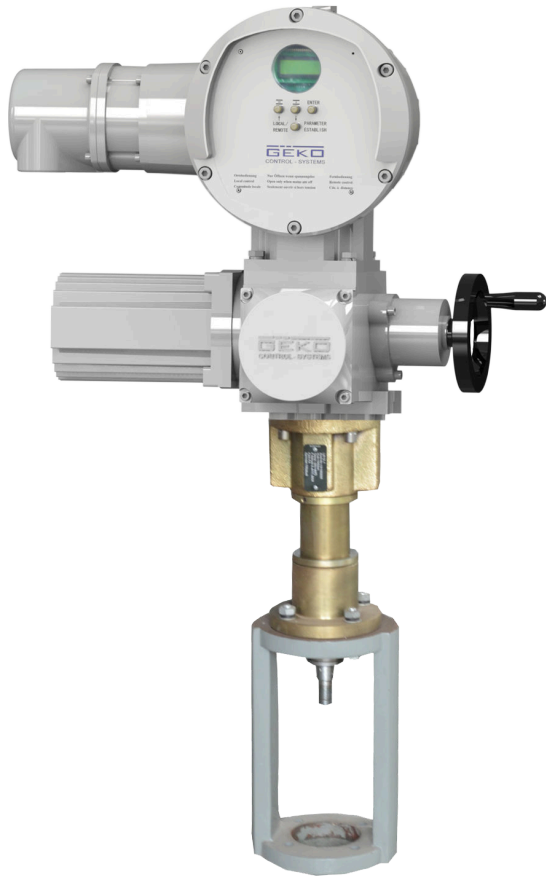

Conventional type

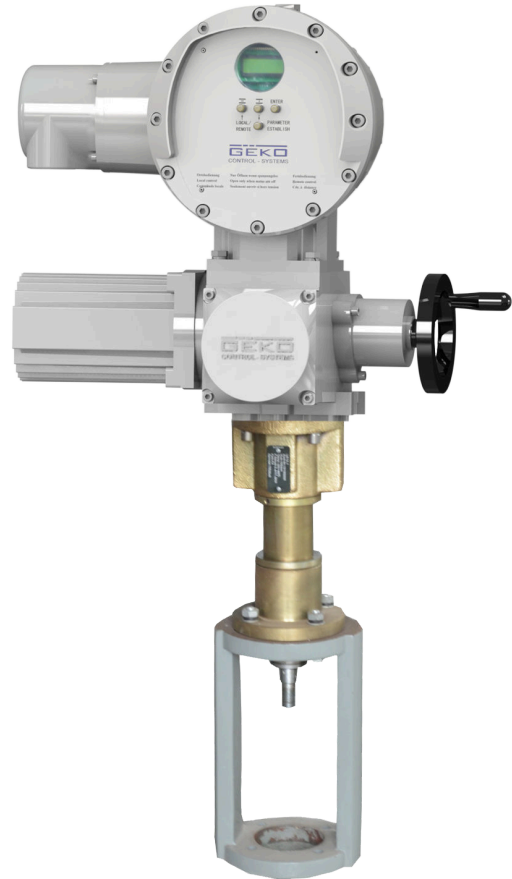

Explosion-proof type

GKSA···Series linear electric actuators technical data

Type	The shaft thrust (KN)	Pushrod speed (mm/min)	Screw pitch (mm)	Flange output
GKSA11.5+LE12.1 GKSA11.0+LE12.1	3.4-11.5	25-200/50-400/100-800	5	F10
GKSA21.5+LE25.1 GKSA21.0+LE25.1	6.9-23	25-200/50-400/100-800	5	F10
GKSA31.5+LE50.1 GKSA31.0+LE50.1	11.7-39	30-240/60-480/120-960	6	F10
GKSA43.5+LE70.1 GKSA43.0+LE70.1	19.2-64	35-280/70-560/140-1120	7	F14
GKSA53.5+LE100.1 GKSA53.0+LE100.1	38.4-128	35-280/70-560	7	F14
GKSA64.5+LE200.1 GKSA64.0+LE200.1	65.2-217	40-320	8	F16

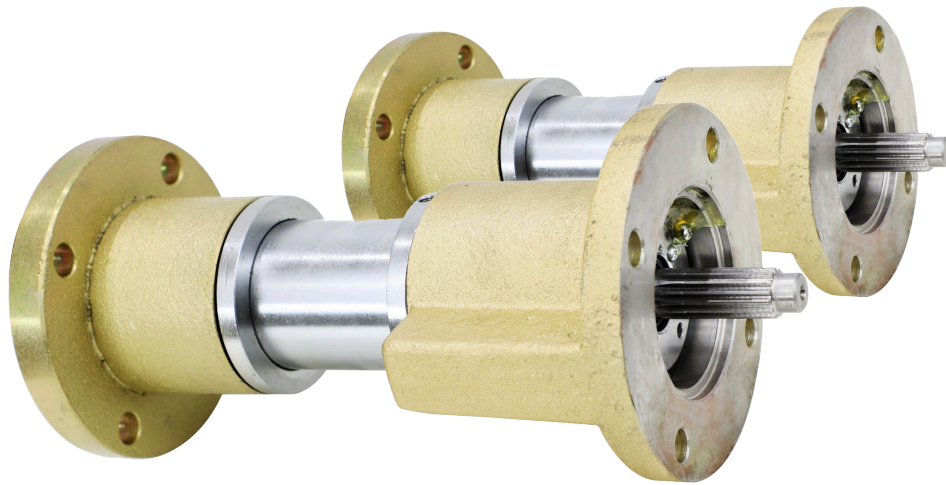

Output thrust (KN) of linear actuator = multi-turn actuator output torque (Nm) / linear propulsion plant conversion coefficient (f)

Linear motion speed of linear actuator output shaft = multi-turn actuator output shaft speed x linear propulsion plant pitch

Thrust(KN)		Type	Maximum stroke (mm)	Mounting flange DIN3358	Pushrod & thread	Screw pitch (mm)	Conversion coefficient f	Matched actuators	Weight (Kg)
Min	Max								
3.4	11.5	LE12.1	50	F10	26x5LH	5	2.6	GKSA11.0	8
			100						9
			200						10
			400						13
			500						14
6.9	23	LE25.1	50	F10	26x5LH	5	2.6	GKSA21.0	8
			100						9
			200						10
			400						13
			500						14
11.7	39	LE50.1	63	F10	32x6LH	6	3.2	GKSA31.0	10
			125						12
			250						15
			400						18
19.2	64	LE70.1	80	F14	40x7LH	7	3.9	GKSA43.0	23
			160						26
			320						32
			400						35
38.4	128	LE100.1	80	F14	40x7LH	7	3.9	GKSA53.0	23
			160						26
			320						32
			400						35
65.2	217	LE200.1	100	F16	48x8LH	8	4.6	GKSA64.0	45
			200						50
			400						62
			500						68

GKSA...Series direct-connected quarter-turn electric actuator



Conventional type



Explosion-proof type

GKSA...Series direct-connected quarter-turn electric actuator technical data

Model	Output torque	Full stroke time (S/90°)	Flange
GKSA11.5+GS40.2 GKSA11.0+GS40.2	80–270	8–64	F07
GKSA11.5+GS63.3 GKSA11.0+GS63.3	150–500	20–160	F10/F12
GKSA21.5+GS63.3 GKSA21.0+GS63.3	300–700	20–160	F10/F12
GKSA21.5+GS80.3 GKSA21.0+GS80.3	320–1080	20–160	F12/F14
GKSA31.5+GS80.3 GKSA31.0+GS80.3	670–1350	20–160	F12/F14
GKSA11.5+GS100.3-VZ4.3 GKSA11.0+GS100.3-VZ4.3	670–2220	20–160	F14/F16
GKSA31.5+GS100.3 GKSA31.0+GS100.3	710–2250	20–160	F14/F16
GKSA21.5+GS125.3-VZ4.3 GKSA21.0+GS125.3-VZ4.3	1360–4520	20–160	F16/F25
GKSA43.5+GS125.3 GKSA43.0+GS125.3	1440–4800	20–160	F16/F25
GKSA21.5+GS160-GZ14(8:1) GKSA21.0+GS160-GZ14(8:1)	3000–10020	40–320	F25/F30
GKSA31.5+GS160-GZ(4:1) GKSA31.0+GS160-GZ(4:1)	3110–10370	20–160	F25/F30
GKSA53.5+GS160 GKSA53.0+GS160	3150–10500	20–160	F25/F30
GKSA21.5+GS200-GZ16(16:1) GKSA21.0+GS200-GZ16(16:1)	5240–17460	80–640	F30/F35
GKSA31.5+GS200-GZ16(8:1) GKSA31.0+GS200-GZ16(8:1)	6190–20630	40–320	F30/F35
GKSA43.5+GS200-GZ16(4:1) GKSA43.0+GS200-GZ16(4:1)	6080–20250	20–160	F30/F35
GKSA53.5+GS250-GZ25(4:1) GKSA53.0+GS250-GZ25(4:1)	12000–40000	20–160	F35/F40

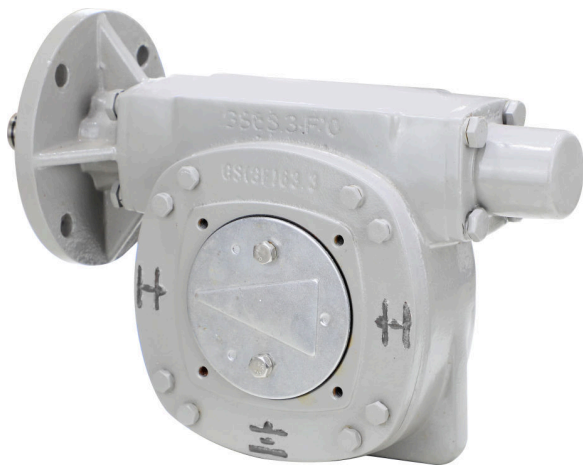

Quarter-turn actuator output torque =
multi-turn actuator output torque X reducer
torque amplification factor f

Quarter-turn actuator full travel time
(seconds/ 90°) = (15x reduction gear ratio)
/ multi-turn actuator output shaft speed

GS...Series direct-connected Gear box technical data

Gear box model	GS40.2	GS50.3	GS63.3	GS80.3	GS100.3			GS125.3				
					VZ2.3	VZ3.3	VZ4.3	VZ2.3	VZ3.3	VZ4.3		
With the Valve Connecting flange DIN ISO 5211	F07	F07/F10	F10/F12	F12/F14	F14/F16			F16/F25				
Maximum output torque Nm	420	350	700	1400	2800			5600				
Rated output torque Nm	300	250	500	1000	2000			4000				
First stage reduction ratio of gearbox GS	21:1	51:1	51:1	53:1	52:1			52:1				
Second stage reduction ratio of gearbox GZ	-	-	-	-	-	2.4:1	3.1:1	4:1	-	2.4:1	3.1:1	4:1
Total reduction ratio of reduction box GS+GZ	-	-	-	-	-	126:1	160:1	208:1	-	126:1	160:1	208:1
Torque amplification factor F	9	16.7	16.3	17.9	18.7	44.4	55.5	74	19.5	45.4	57.9	75.4
The input torque of the correspondent rated output torque	33	15	31	56	107	45	36	27	208	88	69	53
Weight About Kg	3.5	6	10	13.5	25	33	33	33	32	43	43	43
With the GKSA series Connecting flange DIN ISO 5210	F10	F07	F10		F10	F10		F14	F10			
The corresponding GKSA series	GKSA11.0 GKSA11.5	GKSA10.0 GKSA10.5	GKSA1/21.0 GKSA1/21.5	GKSA2/21.0 GKSA2/21.5	GKSA31.0 GKSA31.5	GKSA21.0 GKSA21.5	GKSA21.0 GKSA21.5	GKSA43.0 GKSA43.5	GKSA31.0 GKSA31.5	GKSA21.0 GKSA21.5		
Full trip time with standard configuration (S/90°)	8-64		20-160		20-160	20-160	20-160	20-160	20-160	20-160	20-160	
The total weight of the actuator+gearbox Kg	23	25.5	29.5/30.5	34/46.5	58	53.5	52.5	71	76	63.5		

Gear box model	GS160			GS200			GS250			
	GZ14			GZ16			GZ25			
With the Valve Connecting flange DIN ISO 5211	F25/F30			F30/F35			F35/F40			
Maximum output torque Nm	11250			22500			45000			
Rated output torque Nm	8000			16000			32000			
First stage reduction ratio of gearbox GS	54:1	54:1	54:1	53:1	53:1	53:1	53:1	52:1	52:1	52:1
Second stage reduction ratio of gearbox GZ		4:1	8:1	-	4:1	8:1	16:1	4:1	8:1	16:1
Total reduction ratio of reduction box GS+GZ		218:1	442:1		214:1	434:1	864:1	210:1	426:1	848:1
Torque amplification factor F	21	21	167	20.7	81	165	291	80	162	288
The input torque of the correspondent rated output torque	381	381	48	773	197	97	55	400	198	111
Weight About Kg	80	80	91	140	160	160	170	296	296	308
With the GKSA series Connecting flange DIN ISO 5210	F14	F10	F10	F16	F14	F10	F10	F14		
The corresponding GKSA series	GKSA53.0 GKSA53.5	GKSA31.0 GKSA31.5	GKSA21.0 GKSA21.5	GKSA64.0 GKSA64.5	GKSA43.0 GKSA43.5	GKSA31.0 GKSA31.5	GKSA21.0 GKSA21.5	GKSA53.0 GKSA53.5	GKSA43.0 GKSA43.5	GKSA33.0 GKSA33.5
Full trip time with standard configuration (S/90°)	20-160	20-160	40-320	20-160	20-160	40-320	80-640	20-160	40-320	80-640
The total weight of the actuator+gearbox Kg	144	124	111.5	210	199	193	190.5	360	335	341

GKSA...Series foot-mounted quarter-turn electric actuators



Conventional type



Explosion-proof type

GKSA...Series foot-mounted quarter-turn electric actuators technical data

Model	Output torque	Full stroke time (S/90°)
GKSA11.5+GF40.2 GKSA11.0+GF40.2	80-270	8-64
GKSA11.5+GF63.3 GKSA11.0+GF63.3	150-500	20-160
GKSA21.5+GF63.3 GKSA21.0+GF63.3	300-700	20-160
GKSA21.5+GF80.3 GKSA21.0+GF80.3	320-1080	20-160
GKSA31.5+GF80.3 GKSA31.0+GF80.3	670-1350	20-160
GKSA11.5+GF100.3-VZ4.3 GKSA11.0+GF100.3-VZ4.3	670-2220	20-160
GKSA31.5+GF100.3 GKSA31.0+GF100.3	710-2250	20-160
GKSA21.5+GF125.3-VZ4.3 GKSA21.0+GF125.3-VZ4.3	1360-4520	20-160
GKSA43.5+GF125.3 GKSA43.0+GF125.3	1440-4800	20-160
GKSA21.5+GF160-GZ14(8:1) GKSA21.0+GF160-GZ14(8:1)	3000-10020	40-320
GKSA31.5+GF160-GZ(4:1) GKSA31.0+GF160-GZ(4:1)	3110-10370	20-160
GKSA53.5+GF160 GKSA53.0+GF160	3150-10500	20-160
GKSA21.5+GF200-GZ16(16:1) GKSA21.0+GF200-GZ16(16:1)	5240-17460	80-640
GKSA31.5+GF200-GZ16(8:1) GKSA31.0+GF200-GZ16(8:1)	6190-20630	40-320
GKSA43.5+GF200-GZ16(4:1) GKSA43.0+GF200-GZ16(4:1)	6080-20250	20-160
GKSA53.5+GF250-GZ25(4:1) GKSA53.0+GF250-GZ25(4:1)	12000-40000	20-160

Quarter-turn actuator output torque = multi-turn actuator output torque X reducer torque amplification factor f

Quarter-turn actuator full stroke time (second/90°) = (15x reduction gear ratio) / multi-turn actuator output shaft speed

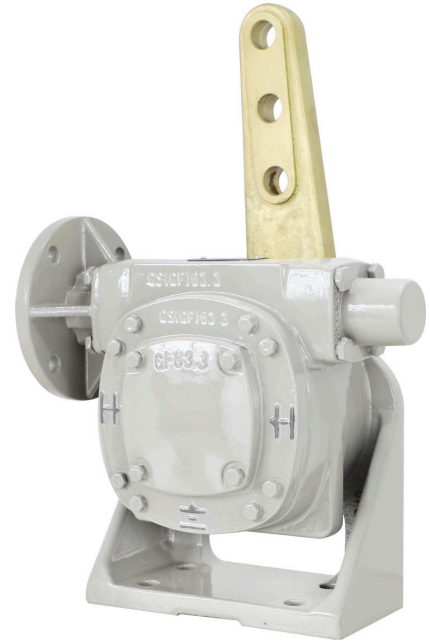

GF...Series foot-mounted crank type gear box technical data

Gear box model	GS40.2	GS50.3	GS63.3	GS80.3	GF100.3			GF125.3				
					VZ2.3	VZ3.3	VZ4.3	VZ2.3	VZ3.3	VZ4.3		
Maximum output torque Nm	420	350	700	1400	2800			5600				
Rated output torque Nm	300	250	500	1000	2000			4000				
First stage reduction ratio of gearbox GF	21:1	51:1	51:1	53:1	52:1			52:1				
Second stage reduction ratio of gearbox GZ	-	-	-	-	-	2.4:1	3.1:1	4:1	-	2.4:1	3.1:1	4:1
Total reduction ratio of reduction box GF+GZ	-	-	-	-	-	126:1	160:1	208:1	-	126:1	160:1	208:1
Torque amplification factor F	9	16.7	16.3	17.9	18.7	44.4	55.5	74	19.5	45.4	57.9	75.4
The input torque of the correspondant rated output torque	33	15	31	56	107	45	36	27	208	88	69	53
Weight About Kg	11	14.5	23	29	50	56	56	56	63	73	73	73
With the GKSA series Connecting flange DIN ISO 5210	F10	F07	F10		F10	F10			F14	F10		
The corresponding GKSA series	GKSA11.0 GKSA11.5	GKSA10.0 GKSA10.5	GKSA11.0 GKSA11.5	GKSA2/21.0 GKSA2/21.5	GKSA2/31.0 GKSA2/31.5	GKSA21.0 GKSA21.5	GKSA21.0 GKSA21.5	GKSA43.0 GKSA43.5	GKSA31.0 GKSA31.5	GKSA21.0 GKSA21.5		
Full trip time with standard configuration (S/90°)	8-64	20-160	20-160	20-160	20-160	20-160	20-160	20-160	20-160	20-160	20-160	20-160
The total weight of the actuator+gearbox Kg	30.5	34	42.5	49.5/62	83	76.5	75.5	102	106	93.5		

Gear box model	GF160			GF200			GF250			
	GZ14			GZ16			GZ25			
Maximum output torque Nm	11250			22500			45000			
Rated output torque Nm	8000			16000			32000			
First stage reduction ratio of gearbox GF	54:1	54:1	54:1	53:1	53:1	53:1	53:1	52:1	52:1	52:1
Second stage reduction ratio of gearbox GZ		4:1	8:1	-	4:1	8:1	16:1	4:1	8:1	16:1
Total reduction ratio of reduction box GF+GZ		216:1	432:1		212:1	424:1	848:1	208:1	416:1	832:1
Torque amplification factor F	24.2	82	164	23.9	82	163	320	80	160	320
The input torque of the correspondant rated output torque	330	98	49	670	196	98	50	400	200	100
Weight About Kg	120	140	140	220	255	255	255			
With the GKSA series Connecting flange DIN ISO 5210	F14	F10	F10	F16	F14	F10	F10	F14		
The corresponding GKSA series	GKSA53.0 GKSA53.5	GKSA31.0 GKSA31.5	GKSA21.0 GKSA21.5	GKSA64.0 GKSA64.5	GKSA43.0 GKSA43.5	GKSA31.0 GKSA31.5	GKSA21.0 GKSA21.5	GKSA53.0 GKSA53.5	GKSA43.0 GKSA43.5	GKSA33.0 GKSA33.5
Full trip time with standard configuration (S/90°)	20-160	40-320	40-320	20-160	20-160	40-320	80-640	20-160	20-320	80-640
The total weight of the actuator+gearbox Kg	184	173	160.5	290	294	288	275.5			

QUALITY IS NOT JUST A MATTER OF TRUST

Actuators must be reliable and dependable. They determine the cycle of precisely defined work processes. Reliability does not begin during commissioning.

For GEKO, this commences with a well-thought out design, careful selection of material used and conscientious production using state-of-the-art machinery. With clearly controlled and supervised production steps we pay close attention to the environment.

The importance of environmentally sound production is reflected in our certifications according to ISO 9001 and ISO 14001.

However, quality management is no one-time or static matter. It has to be proven day by day. Numerous audits by our customers and independent institutes confirm these high standards.



中国国家强制性产品认证证书



证书编号：2021322307003763

认证委托人名称：盖科流体控制技术（常州）有限公司

认证委托人地址：江苏省常州市天宁区浦前村委驴场头 105 号

生产者名称：盖科流体控制技术（常州）有限公司

生产者地址：江苏省常州市天宁区浦前村委驴场头 105 号

生产企业名称：盖科流体控制技术（常州）有限公司

生产企业地址：江苏省常州市天宁区浦前村委驴场头 105 号

产品名称：变频电动执行器

系列、规格、型号：GKSAEXC11.0, GKSAEXC21.0, GKSAEXC31.0, GKSAEXC43.0,
GKSAEXC11.5, GKSAEXC21.5, GKSAEXC31.5, GKSAEXC43.5

标准：GB 3836.1-2010、GB 3836.2-2010

上述产品符合强制性产品认证实施规则 CNCA-C23-01:2019 的要求，特发此证。

发证日期：2021 年 3 月 1 日

有效期至：2025 年 9 月 14 日

首次发证日期：2021 年 3 月 1 日

证书有效期内本证书的有效性依据发证机构的定期监督获得保持。

本证书的相关信息可通过国家认监委网站 www.cnca.gov.cn 查询



批准：



上海仪器仪表自控系统检验测试所有限公司

<http://www.sitias.com.cn>

中国·上海·漕宝路103号200233

电话：+86 21 64510844

S 0004642



CERTIFICATE FOR CHINA COMPULSORY PRODUCT CERTIFICATION



CERTIFICATE NO: 2021322307003763

APPLICANT: Geko Flow Control Technology(Chanzhou) Co., Ltd
ADDRESS: No.105, Lvchangtou, Puqian Village, Tianning District, Changzhou
MANUFACTURER: Geko Flow Control Technology(Chanzhou) Co., Ltd
ADDRESS: No.105, Lvchangtou, Puqian Village, Tianning District, Changzhou
FACTORY: Geko Flow Control Technology(Chanzhou) Co., Ltd
ADDRESS: No.105, Lvchangtou, Puqian Village, Tianning District, Changzhou

PRODUCTNAME: variable speed electric actuators
SERIES,SPECIFICATION,MODEL: GKSAEXC11.0, GKSAEXC21.0, GKSAEXC31.0, GKSAEXC43.0, GKSAEXC11.5, GKSAEXC21.5, GKSAEXC31.5, GKSAEXC43.5
STANDARDS: GB 3836.1-2010、 GB 3836.2-2010

This is to certify that the above mentioned product(s)complies with the requirements of implementation rules for compulsory certification (REFNO. CNCA-C23-01:2019).

Valid from:March 1, 2021 **Valid until:** September 14, 2025

Date of original certification:March 1, 2021

The validity of this certificate is subject to positive result of the regular follow up inspection by issuing certification body until the expiry date.

This certificate is available through CNCA’s website: www.cnca.gov.cn



APPROVAL:

Guo AiHua



Shanghai Inspection and Testing Institute of Instruments and Automation Systems Co., Ltd.

<http://www.sitiias.com.cn>

Building 9,103 Cao Bao Road, Shanghai 200233,China

Tel: +86 21 64510844

s 0004543



中国国家强制性产品认证证书



证书编号：2021322307003763

附 件

产品名称： 变频电动执行器

型号规格： GKSAEXC11.0, GKSAEXC21.0, GKSAEXC31.0, GKSAEXC43.0,
GKSAEXC11.5, GKSAEXC21.5, GKSAEXC31.5, GKSAEXC43.5

防爆标志： Ex d IIC T4 Gb

电气参数： AC380V、AC220V

批 准：



上海仪器仪表自控系统检验测试所有限公司

<http://www.sitias.com.cn>

中国·上海·漕宝路103号200233

电话：+86 21 64510844

第 1 页 共 1 页

EU DIRECTIVES

Declaration of Incorporation in compliance with the Machinery Directive and Declaration of Conformity according to the Low Voltage and EMC Directives.

According to the Machinery Directive, GEKO actuators and valve gearboxes are considered as partly completed machinery. By means of the Declaration of Incorporation, GEKO certify that during the design stage of the devices, the fundamental safety requirements stipulated in the Machinery Directive were applied.

GEKO actuators fulfil the requirements of the Low Voltage and EMC Directives. This has been proved in various exams and extensive tests. Consequently, GEKO issue a Declaration of Conformity in compliance with the Low Voltage and EMC Directives.

Declarations of Incorporation and of Conformity are combined in a single certificate.

According to the Low Voltage and EMC directives, the devices are labelled with the CE mark.



INSPECTION CERTIFICATE

After assembly, every single actuator is thoroughly tested and torque switches are calibrated. This process is recorded in the inspection certificate.

CERTIFICATES

Notified bodies perform type tests on the actuators to prove whether the devices are suitable for specifically defined applications. One example are the tests to prove electrical safety for the North American market. For all devices mentioned in this brochure, relevant certificates are available.

Where can I get the certificates?

All confirmations, records and certificates are filed at GEKO and provided as printed or digital version on request.

The documents can be downloaded from the GEKO website at any time; some of them are password protected.

> www.geko-valves.de



Ortsbedienung
Local control
Commande locale
Ⓢ

G E K O

C O N T R O L - S Y S T E M S

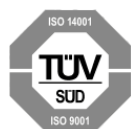

Geko Union /Geko Fluid Control GmbH
Schwalbenstr.28/2 70794
Filderstadt Germany
Tel. +49 (0) 711-21570744
Fax +49 (0) 711-21570744
www.geko-valves.de
info@geko-valves.de



**Geko Flow Control Technology
(Changzhou) Co., Ltd**
No:101 QingyangNorth Road,Changzhou
213004,P.R.China
Tel. +86 519 83983155
Fax +86 519 83983133
www.geko-valves.com
geko@geko-valves.com